

SG 6475

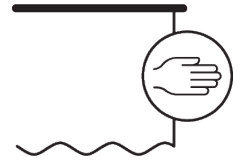

INFORMATION PRODUIT

- **Mode de commande:** Tirage main
- **Gamme:** S - M
- **Installation:** Plafond
- **Couleurs:** Blanc RAL 9016 ou Aluminium, couleurs spéciales possibles
- **Tissus:** Se référer à la collection tissu Silent Gliss

Caractéristiques:

- Glisseurs Bi-Composants
- Option Glisseurs Wave Bi-Composants
- Cintrable

SPÉCIFICATION SYSTÈME

A. PROFIL

Profil et information de cintrage

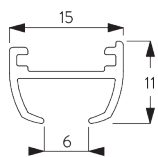

SG 6475p

Profil

Rayon:
8 cm, 12 cm, 16 cm,
>25 cm

B. PRISE DE MESURE

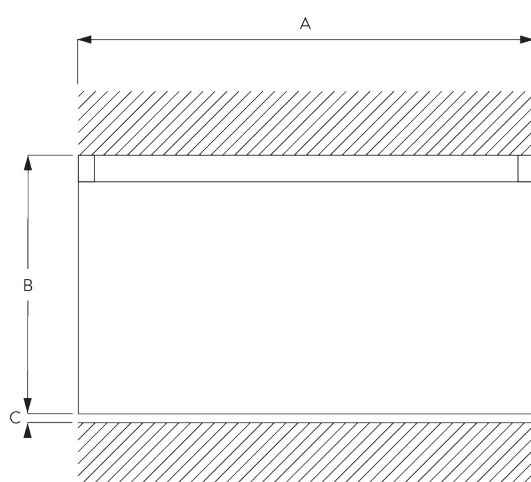

A: Largeur système

B: Hauteur système

C: Distance entre bas du rideau et le sol

INSTALLATION

A. INSTRUCTION DE POSE

Pour des informations détaillées, se référer au site web Silent Gliss.

Points de fixation

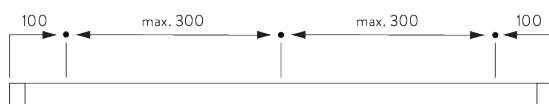

B. FIXATION PLAFOND

Brides SG 3060

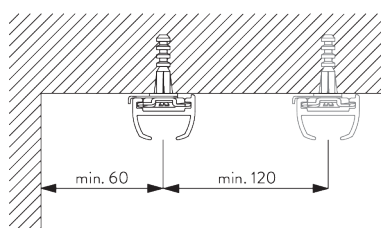

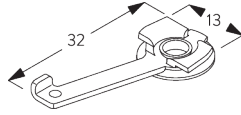

SG 3060
Bride

OPTIONS SYSTÈME

A. WAVE

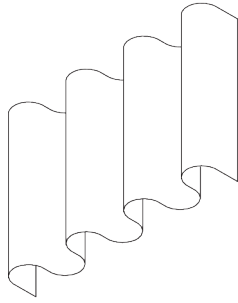

SG 11295

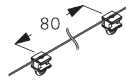

SG 11302



SG 2255



SG 2256

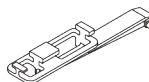

SG 6364



SG 6365

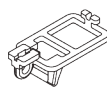

SG 6366

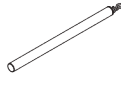

SG 10430-34

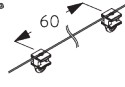

SG 11303

Composants standard:

- SG 11295 Vis d'arrêt
- SG 11302 Glisseurs Wave bi-composants 80 mm

Composants en option (rayon >25 cm):

- SG 2255 Frein
- SG 2256 Frein
- SG 6364 Extension Wave
- SG 6365 Crochet Wave
- SG 6366 Chariot Wave pour lance rideau
- SG 10430-34 Lance rideau
- SG 11303 Glisseur Wave bi-composants 60 mm



SG 3582

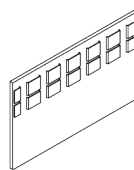

SG 6349

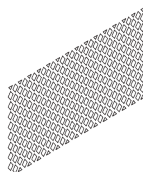

SG 6363

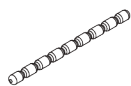

SG 10075



SG 10076

Composants de rideaux:

- SG 3582 Crochet
- SG 6349 Ruban Wave transparent
- SG 6363 Ruban à repasser
- SG 10075 Fil à plomb 50 gr/m
- SG 10076 Barre de lestage

Paquet rideau Wave - Glisseur Bi-composants (standard)

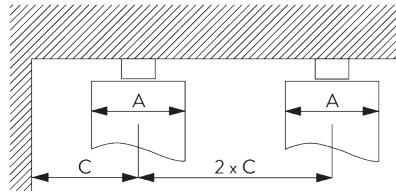
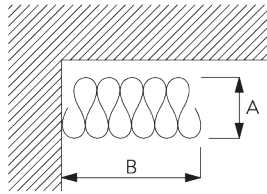

A = Epaisseur du Wave
B = Largeur paquet rideau
C = Ecartement minimum





Glisseur Bi-composants SG 11302	Nombre de poches entre crochets	Ampleur rideau Approximative	Epaisseur du Wave A	Largeur paquet rideau B*	Ecartement minimum C
80	6	~2.1	140	180 mm par ml de tringle	90
80	7	~2.3	160	180 mm par ml de tringle	100

Glisseur Bi-composants SG 11303	Nombre de poches entre crochets	Ampleur rideau Approximative	Epaisseur du Wave A	Largeur paquet rideau B*	Ecartement minimum C
60	4	~2.1	100	230 mm par ml de tringle	70
60	5	~2.3	120	230 mm par ml de tringle	80



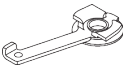

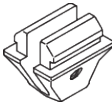

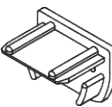
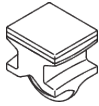

**Largeur paquet rideau B lors de l'utilisation du bras d'extension SG 6364 augmente de 150 mm par rideau!*

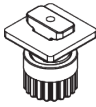
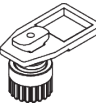

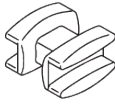
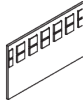

ACCESSOIRES

A. ACCESSOIRES STANDARDS

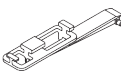
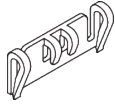
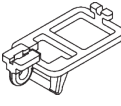
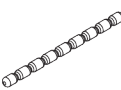
	SG 3060 Bride
	SG 6065 Fixateur avec oeillet
	SG 6245 Ressort d'arrêt
	SG 6475p Profil
	SG 6476 Embout
	SG 11305 Glisseur Bi-composants pour couture directe

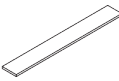
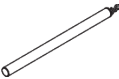
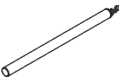
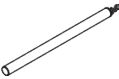
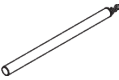
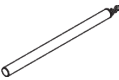
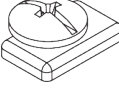
B. ACCESSOIRES EN STANDARDS

	SG 2255 Frein
	SG 2256 Frein
	SG 3012 Agrafe à coudre
	SG 3062 Pièce de raccord
	SG 3582 Agrafe Delrin
	SG 3599 Crochet pour galon à froncer
	SG 6057 Glisseur
	SG 6082 Glisseur à coudre
	SG 6349 Ruban Wave transparent
	SG 6363 Ruban à repasser
	SG 6364 Extension
	SG 6365 Crochet Wave
	SG 6366 Chariot pour lance rideau
	SG 10075 Fil à plomb 50 gr/m

	SG 10076 Barre de lestage
	SG 10430 Lance rideau aluminium avec crochet, 50cm
	SG 10431 Lance rideau aluminium avec crochet, 75 cm
	SG 10432 Lance rideau aluminium avec crochet, 100 cm
	SG 10433 Lance rideau aluminium avec crochet, 125 cm
	SG 10434 Lance rideau aluminium avec crochet, 150 cm
	SG 11295 Arrêt
	SG 11300 Glisseur Bi-composants
	SG 11301 Glisseur Bi-composants en barrette
	SG 11302 Glisseur Wave Bi-composants 80 mm
	SG 11303 Glisseur Wave Bi-composants 60 mm

